

Model # 64-0918

Easy Assembly & Instructions

QUEEN VICTORIA™ SOCCER TABLE



Congratulations on your purchase of the Fat Cat™ Queen Victoria™ Soccer Table!

This manual is to instruct you during the assembly of your new table. Be sure to have another person help you.

Careful handling of all parts during assembly will ensure many years of enjoyment!

Warning to Parents:

Please read instructions carefully.
Not for use by children without
adult supervision.



PRO GAME TABLES

This manual is provided to instruct you during the assembly of your new Fat Cat™ Queen Victoria™ Soccer Table. Please refer to it as necessary. Be sure to have another person help you assemble the table.

Careful handling of all parts during assembly will ensure many years of enjoyment!

H PRO TIP H

Arrange all of your tools before you begin assembly.

Tools

Assembly of the Fat Cat™ Queen Victoria™ Soccer Table requires the following common tools:

- Phillips screwdriver
- Level
- Allen wrench (included)

Assembling Your Queen Victoria™ Soccer Table

Step 1. Attaching the side aprons

Working bottom side up on a clean, soft surface, attach (#23) side apron panels to (#18) base using (#19) screws.

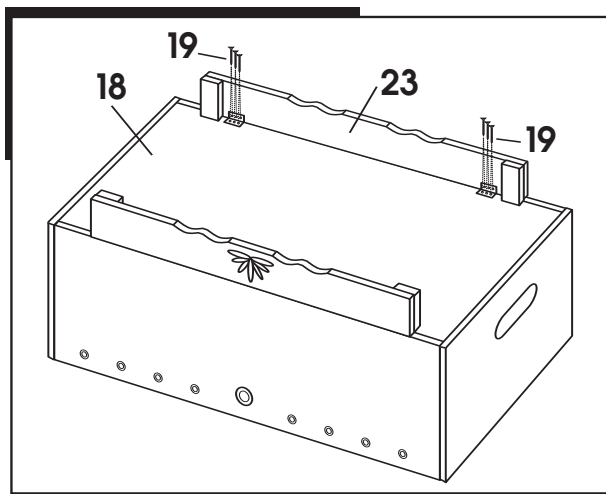

Step 2. Attaching the end aprons

Attach (#24) end apron panels to (#18) base using (#19) Phillips screws.

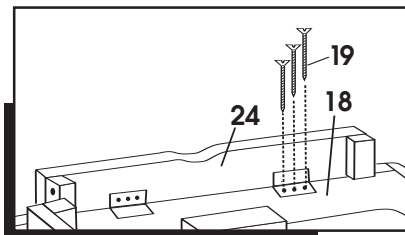

Step 3. Attaching the legs

Attach (#14) legs to corners of playing field using (#16) washer, (#17) spring washer, and (#15) screw. Screw (#8) leg levelers part way into predrilled holes in the bottom of each leg. With the help of another person, flip table right side up and adjust leg levelers one at a time by turning until table rests perfectly level to the floor. This helps ensure that the balls return properly during play.

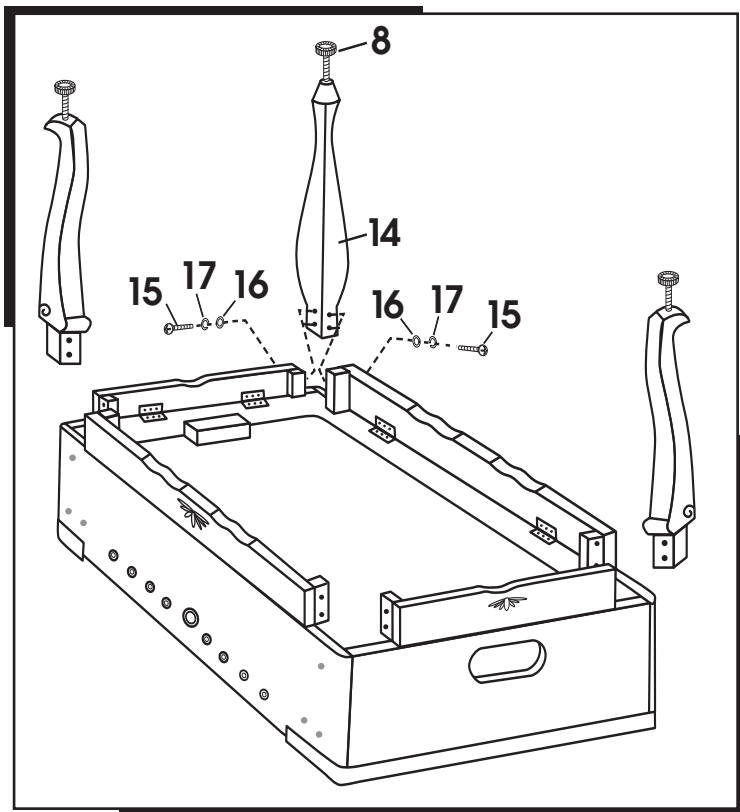

Step 4. Placing the player rods

Thread the playing rods through the bearing holes in the sides of the cabinet in the following order: (#1) handle to the right, (#2) handle to the right, (#1) handle to the left, (#3) handle to the right, (#3) handle to the left, (#1) handle to the right, (#2) handle to the left, (#1) handle to the left. Do NOT attach rod end caps.

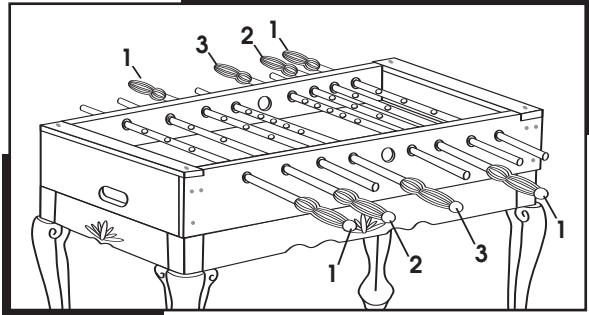

PRO TIP Using silicone spray on the player rods helps ensure smoother play.

Step 5. Attaching the players

Blue Team: Standing on the right side of the table, pull the uncapped end of the (#1) three-hole player rod through the bearing hole on the opposite side of the table, keeping it threaded through the bearing hole nearest you.

Thread (#7) PVC washer, (#6) rubber bumper, (#7) PVC washer, three (#4) Blue Foosmen, (#7) PVC washer, (#6) rubber bumper and (#7) PVC washer. Secure (#4) Blue Foosmen to player rod with (#21) screw and (#22) lock nut.

Continue with positions two, four and six before moving to the other side of the table to assemble the red team.

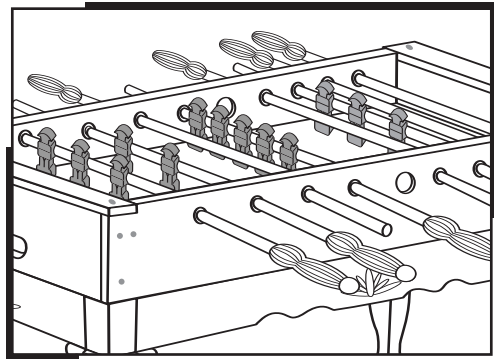
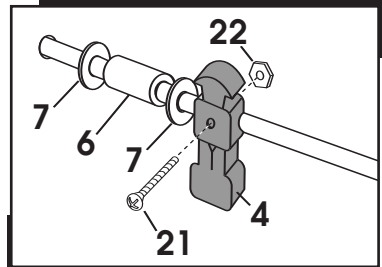

Step 6. Attaching the players

Repeat Step 5 for the (#5) Red team.

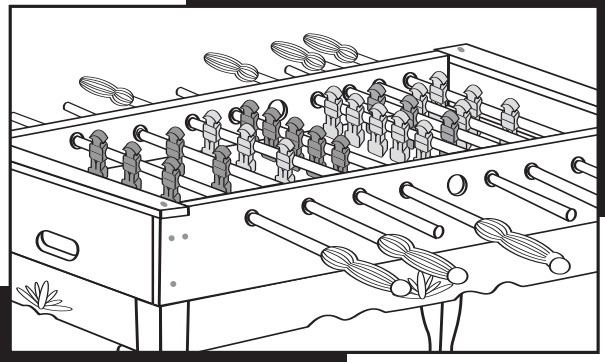

Step 7. Assembling the player rods

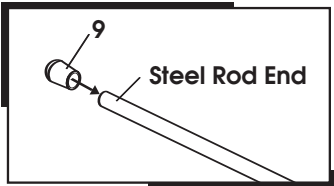

Rethread player rods through opposite bearing hole and slide (#9) rod end cap onto rods.

Step 8. Adding the finishing touches

Set (#10) ball entries into holes on side of playing field. Secure with two (#11) Phillips head screws.

Attach (#12) score racks on each side of playing field with two (#13) Phillips round head screws.



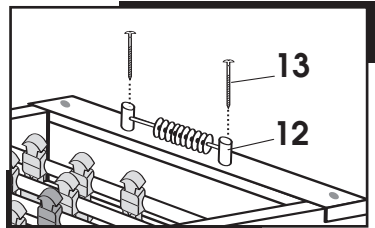
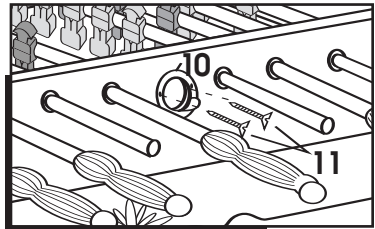



Tap (#25) wood plugs into screw holes along outside of table.

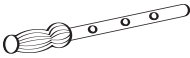
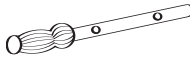
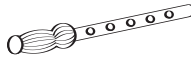
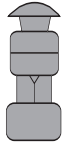
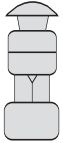
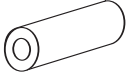
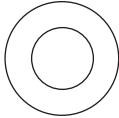
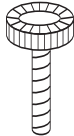
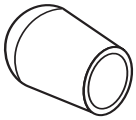

You are now ready to play!

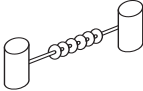

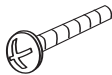



Queen Victoria™ Soccer Table

Parts List

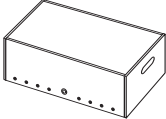
<p>#1</p>  <p>3-Hole Steel Rod 4 pieces</p>	<p>#2</p>  <p>2-Hole Steel Rod 2 pieces</p>	<p>#3</p>  <p>5-Hole Steel Rod 2 pieces</p>	<p>#4</p>  <p>Blue Fooman 13 pieces</p>
<p>#5</p>  <p>Red Fooman 13 pieces</p>	<p>#6</p>  <p>Rubber Bumper 16 pieces</p>	<p>#7</p>  <p>$\frac{5}{8}$" x 38mm PVC Washer 32 pieces</p>	<p>#8</p>  <p>Leg Leveler 4 pieces</p>
<p>#9</p>  <p>Rod End Cap 8 pieces</p>	<p>#10</p>  <p>Ball Entry 2 pieces</p>	<p>#11</p>  <p>$\frac{3}{8}$" Phillips Screw 4 pieces</p>	<p>#12</p>  <p>Score Rack 2 sets</p>
<p>#13</p>  <p>$\frac{1}{8}$" Phillips Round Head Screw 4 pieces</p>	<p>#14</p>  <p>Legs 4 pieces</p>	<p>#15</p>  <p>$\frac{1}{4}$" x 3" Screw 16 pieces</p>	<p>#16</p>  <p>Metal Washer 16 pieces</p>

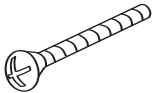
Queen Victoria™ Soccer Table

Parts List

<p>#17</p>  <p>Spring Washer 16 pieces</p>	<p>#18</p>  <p>Base 1 pieces</p>	<p>#19</p>  <p>30° Phillips Screw 12 pieces</p>	<p>#20</p>  <p>White Ball 4 pieces</p>
<p>#21</p>  <p>$\frac{5}{32}$" x 28mm Screw 26 pieces</p>	<p>#22</p>  <p>$\frac{5}{32}$" x 28mm Lock Nut 26 pieces</p>	<p>#23</p>  <p>Side Apron 2 pieces</p>	<p>#24</p>  <p>End Apron 2 pieces</p>
<p>#25</p>  <p>Wood Plug</p>			

WARRANTY INFORMATION

90 Day Warranty on Queen Victoria™ Soccer Table

Manufacturer warrants to the original retail purchaser, this product to be free from defects in material and workmanship for a period of ninety (90) days from the date of purchase.

Should this product become defective due to material or workmanship within the warranty period, contact our Customer Service Department. This warranty is not transferable and does not cover normal wear and tear, or damage caused by improper handling, installation or use of this product. This warranty is also void if product is in any way abused, damaged, or modified from its original state, or if used for other than indoor residential use. This warranty gives you specific legal rights, and you may have other rights which vary from state to state.

DO NOT RETURN TO STORE

For all returns and warranty coverage, please visit our website at www.gldmfg.com or call 1-800-225-7593.

Please provide model number, serial number and/or part number when you call. Numbers can be found on outside of packaging.



PRO GAME TABLES

GLD Products

S84 W19093 Enterprise Drive
Muskego, WI 53150 USA
800 225 7593 • FAX 800 841 6944
Web Site: www.gldmfg.com
Email: gld@gldmfg.com