

Model # 64-0919

Easy Assembly & Instructions

ARCTIC™ SOCCER TABLE



Congratulations on your purchase of the Fat Cat™ Arctic™ Soccer Table!

This manual is to instruct you during the assembly of your new table. Be sure to have another person help you.

Careful handling of all parts during assembly will ensure many years of enjoyment!

Warning to Parents:

Please read instructions carefully.
Not for use by children without
adult supervision.



PRO GAME TABLES

This manual is provided to instruct you during the assembly of your new Fat Cat™ Arctic™ Soccer Table. Please refer to it as necessary. Be sure to have another person help you assemble the table.

Careful handling of all parts during assembly will ensure many years of enjoyment!

PRO TIP

Arrange all of your tools before you begin assembly.

Tools

Assembly of the Fat Cat™ Arctic™ Soccer Table requires the following common tools:

- Phillips screwdriver
- Level

Assembling Your Arctic™ Soccer Table

Step 1. Assembling the playing surface

Working upside down on a clean soft surface, align the predrilled holes of the (#18) playing surface with the (#17) end panels and attach using the (#7) bolts and (#8) washers.

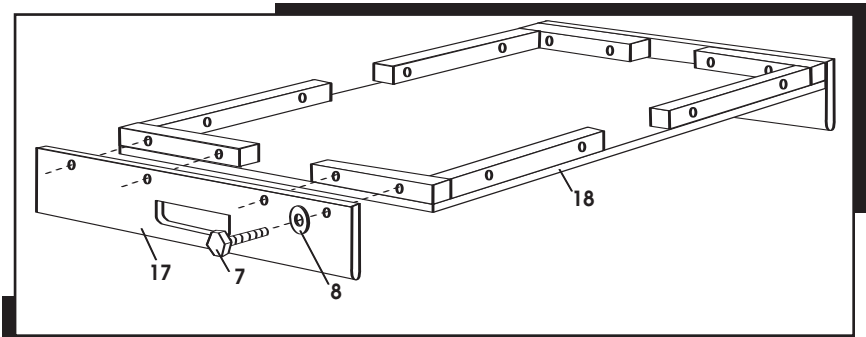

Step 2. Assembling the player rods

Gather the player rods (#22-#27) placing them in the following order: (#26) Home, three man rod; (#25) Home, two man rod; (#23) Visitor, three man rod; (#27) Home, five man rod; (#24) Visitor, five man rod; (#26) Home, three man rod; (#22) Visitor, two man rod; (#23) Visitor three man rod. The pre-drilled holes at one end of each rod should face as follows: Left for home and right for visitor. Place one end of each player rod through the bearing holes in the (#16) side panels.

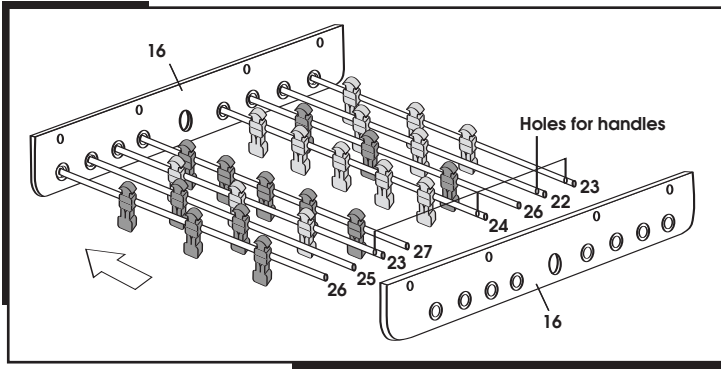

PRO TIP

Using silicone spray on the player rods helps ensure smoother play.

Step 3. Assembling the cabinet

Lay the playing field from step 1 onto the assembled player rods aligning the predrilled holes of the (#18) playing surface with the (#16) side panels. Align the other (#15) side panels to the outside, aligning the predrilled holes for all three pieces and attach using (#6) bolt and (#8) washer.

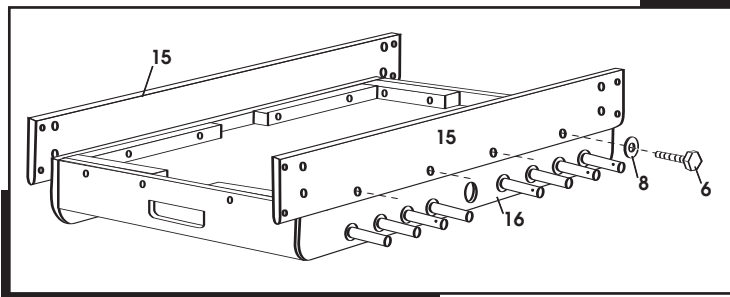

Step 4. Attaching the end panels

Slide the (#14) end panels into place and secure with (#5) nut, (#4) washer and (#3) bolt.

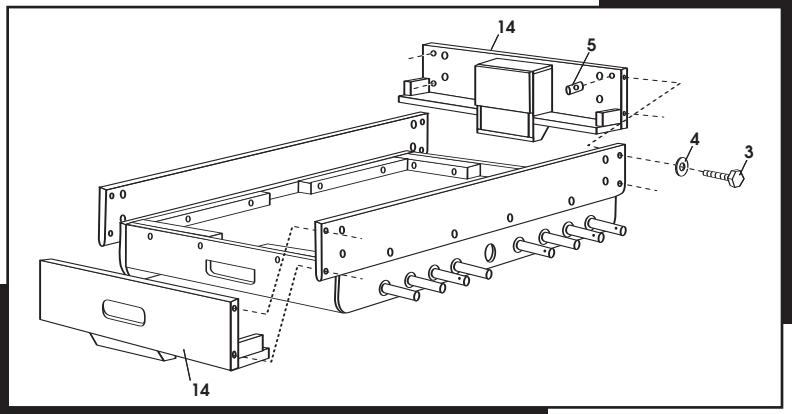

Step 5. Assembling and attaching the legs

Insert (#20) leg supports into openings in (#19) legs and snap into place. Attach to cabinet using (#1) bolt and (#2) washer. Screw (#13) leg levelers part way into predrilled holes in the bottom of each (#19) leg. With the help of another person, carefully flip table right side up and adjust leg levelers one at a time by turning until table rests perfectly level to the floor. This helps ensure that the balls return properly level during play.

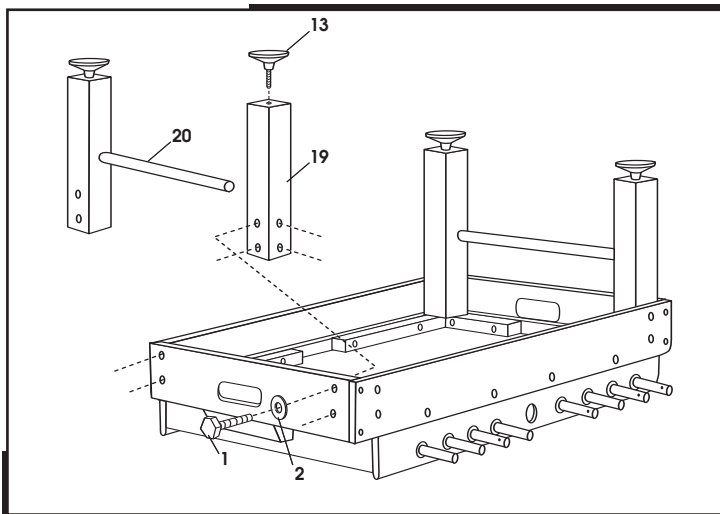

Step 6. Adding the finishing touches





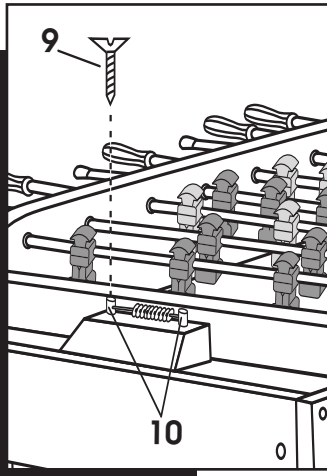
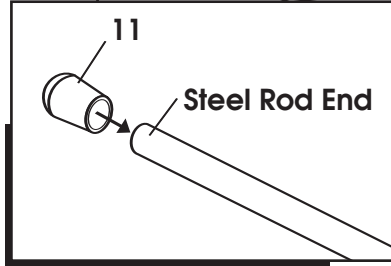
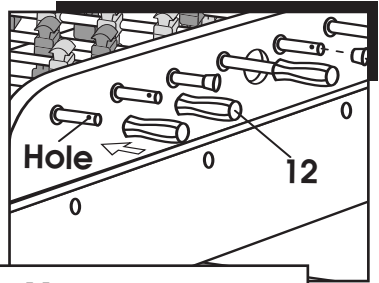

With the table right side up, attach (#12) handles to the ends of player rods (#22-#27) that have pre-drilled holes. Snap (#11) rod end caps on other end.

Attach (#10) scoring system to each end of the playing field with (#9) Phillips head screws.

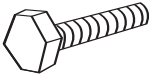

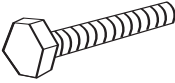
You are now ready to play!

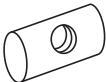
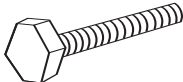
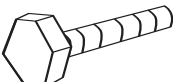

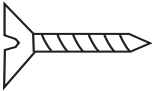
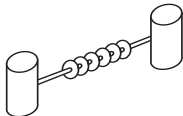
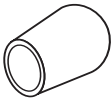
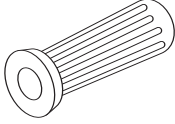
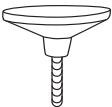
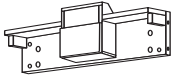
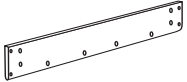
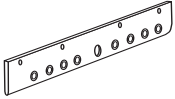
Arctic™ Soccer Table Parts List

<p>#1</p>  <p>$\frac{3}{8}$" x $1\frac{1}{2}$" Bolt 16 pieces</p>	<p>#2</p>  <p>$\frac{3}{8}$" x 22mm Washer 16 pieces</p>	<p>#3</p>  <p>$\frac{1}{4}$" x $2\frac{1}{4}$" Bolt 8 pieces</p>	<p>#4</p>  <p>$\frac{1}{4}$" Washer 8 pieces</p>
<p>#5</p>  <p>$\frac{1}{4}$" Nut 8 pieces</p>	<p>#6</p>  <p>$\frac{5}{16}$" x $2\frac{1}{2}$" Bolt 8 pieces</p>	<p>#7</p>  <p>$\frac{5}{16}$" x $1\frac{3}{4}$" 8 pieces</p>	<p>#8</p>  <p>$\frac{5}{16}$" Washer 16 pieces</p>
<p>#9</p>  <p>$1\frac{3}{4}$" Phillips Screw 4 pieces</p>	<p>#10</p>  <p>Scoring System 2 Sets</p>	<p>#11</p>  <p>Rod End Cap 8 pieces</p>	<p>#12</p>  <p>Handle 8 pieces</p>
<p>#13</p>  <p>Leg Leveler 4 pieces</p>	<p>#14</p>  <p>End Panel 2 pieces</p>	<p>#15</p>  <p>Side Panel 2 pieces</p>	<p>#16</p>  <p>Side Panel 2 pieces</p>

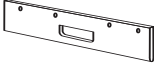
Arctic™ Soccer Table Parts List

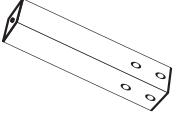
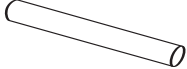
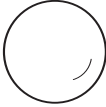
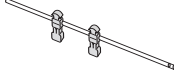
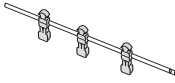
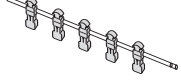
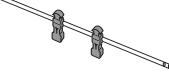
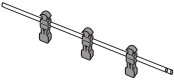
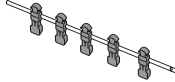
#17  End Panel 2 pieces	#18  Playing Surface 1 piece	#19  Leg 4 pieces	#20  Leg Support Bar 2 pieces
#21  Ball 4 pieces	#22  Visitor 2-Man Rod 1 piece	#23  Visitor 3-Man Rod 2 pieces	#24  Visitor 5-Man Rod 1 piece
#25  Home 2-Man Rod 1 piece	#26  Home 3-Man Rod 2 pieces	#27  Home 5-Man Rod 1 piece	

WARRANTY INFORMATION

90 Day Warranty on Arctic™ Soccer Table

Manufacturer warrants to the original retail purchaser, this product to be free from defects in material and workmanship for a period of ninety (90) days from the date of purchase.

Should this product become defective due to material or workmanship within the warranty period, contact our Customer Service Department. This warranty is not transferable and does not cover normal wear and tear, or damage caused by improper handling, installation or use of this product. This warranty is also void if product is in any way abused, damaged, or modified from its original state, or if used for other than indoor residential use. This warranty gives you specific legal rights, and you may have other rights which vary from state to state.

DO NOT RETURN TO STORE

For all returns and warranty coverage, please visit our website at www.gldmfg.com or call 1-800-225-7593.

Please provide model number, serial number and/or part number when you call. Numbers can be found on outside of packaging.



PRO GAME TABLES

GLD Products

S84 W19093 Enterprise Drive
Muskego, WI 53150 USA
800 225 7593 • FAX 800 841 6944
Web Site: www.gldmfg.com
Email: gld@gldmfg.com