

Model # 64-1013

Easy Assembly Instructions

POCKEY™
2 IN 1 GAMETABLE



DO NOT RETURN TO STORE

For all returns and warranty coverage, please call:

**GLD Products
1-800-225-7593**

Please provide model number, serial number and/or part number when you call. Numbers can be found on outside of packaging.



PRO GAME TABLES

Congratulations on your purchase of the Fat Cat™ Aluminum Pockey™ 2 in 1 Gametable!

This manual is to instruct you during the assembly of your new table. Four people are required for some steps.

Careful handling of all parts during assembly will ensure many years of enjoyment!

WARNING: Changing of game should be done under adult supervision.

Rotating table may pose a finger pinching hazard for young children. Please exercise caution.

Never open fan compartment while fan is running. To do so may cause serious injury.

Careful handling of all parts during assembly will ensure many years of enjoyment!

PRO TIP

Arrange all of your tools before you begin assembly.

TOOLS

Assembly of the Pockey™ 2 in 1 Gametable requires the following common tools:

- Phillips screwdriver
- Wrench (included)
- Level

Assembling Your Aluminum Pockey™ 2 in 1 Gametable!

STEP 1. Pedestal Assembly

Carefully remove two (#18) pedestals, two (#19) pedestal supports, four (#15) levelers, eight (#8) $\frac{1}{2}$ " Allen bolts, eight (#12) $\frac{7}{16}$ " washers, and three (#5) $1\frac{1}{2}$ " screws from packaging. Insert levelers into pre-drilled holes in bottom of bases and secure part way.

Insert pedestals into bases as shown, and secure each with three (#5) $1\frac{1}{2}$ " flat head screws and four (#8) $\frac{1}{2}$ " Allen bolts inserted through four (#12) $\frac{7}{16}$ " washers.

STEP 2. Attaching the Table Locks

Attach two (#16) locks to outside of each pedestal using (#13) $1\frac{1}{2}$ " round head screws and (#10) $\frac{5}{16}$ " washer.

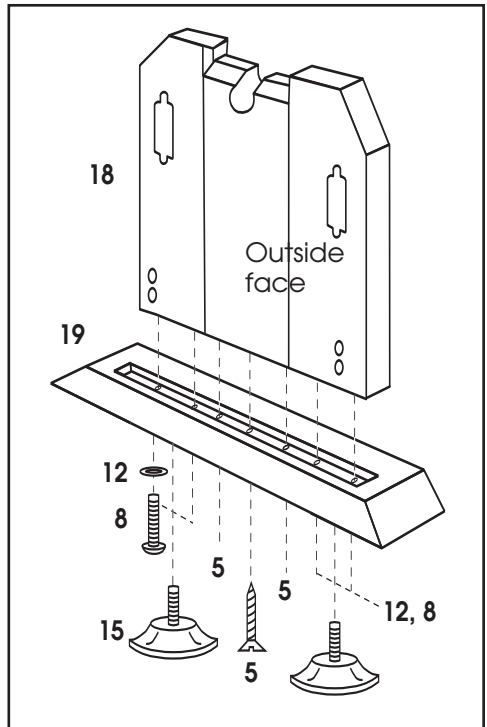
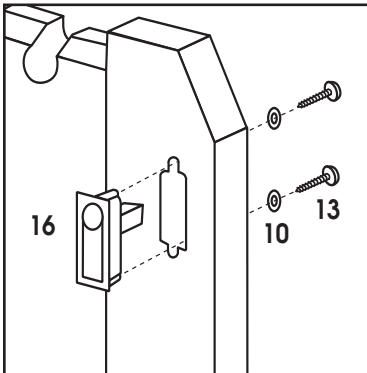

STEP 3. Assembling the Base

With the help of another person, loosely attach (#17) side rails to the pedestals using (#4) $\frac{5}{16}$ " washers, (#3) $2\frac{1}{2}$ " hex bolts and (#14) bolt stop as shown.

On inside of side rail secure bolt stop with (#1) $\frac{5}{16}$ " hex bolt and large (#11) washer.

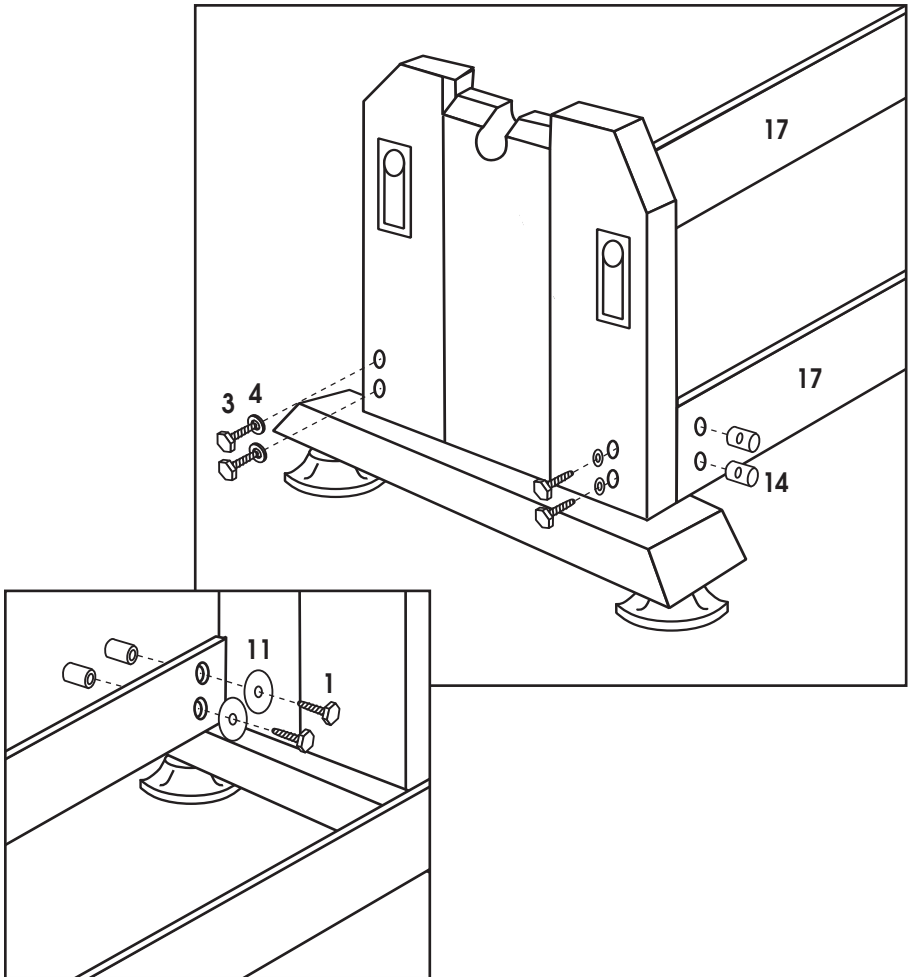

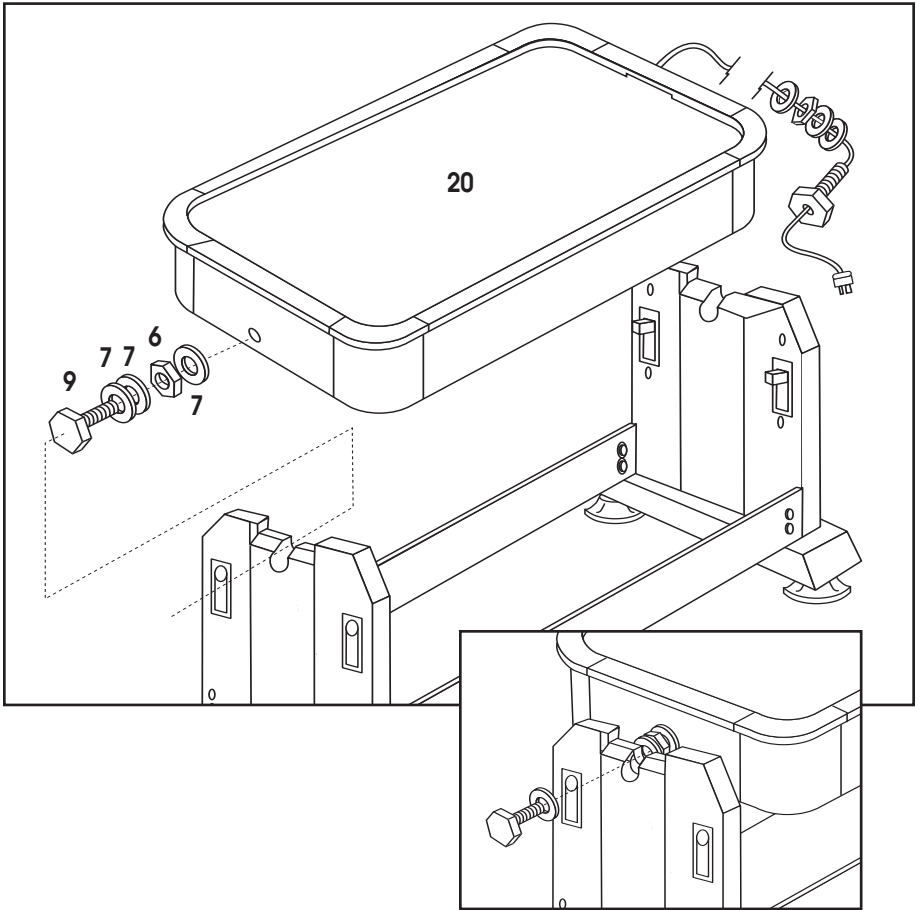

STEP 4. Attach the Rotating Table Top

Slide two (#7) washers, one (#6) hex nut and one more (#7) washer onto (#9) bolt. Insert bolt into pre-drilled hole at end of (#20) table top. Repeat for other end. With the help of three other people, lift the table top and rest it in the center groove on the top of each pedestal. The pedestal should rest between the first two (#7) washers.

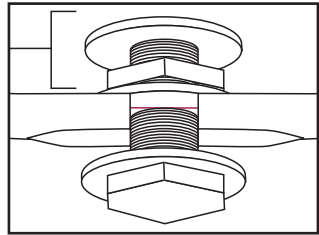

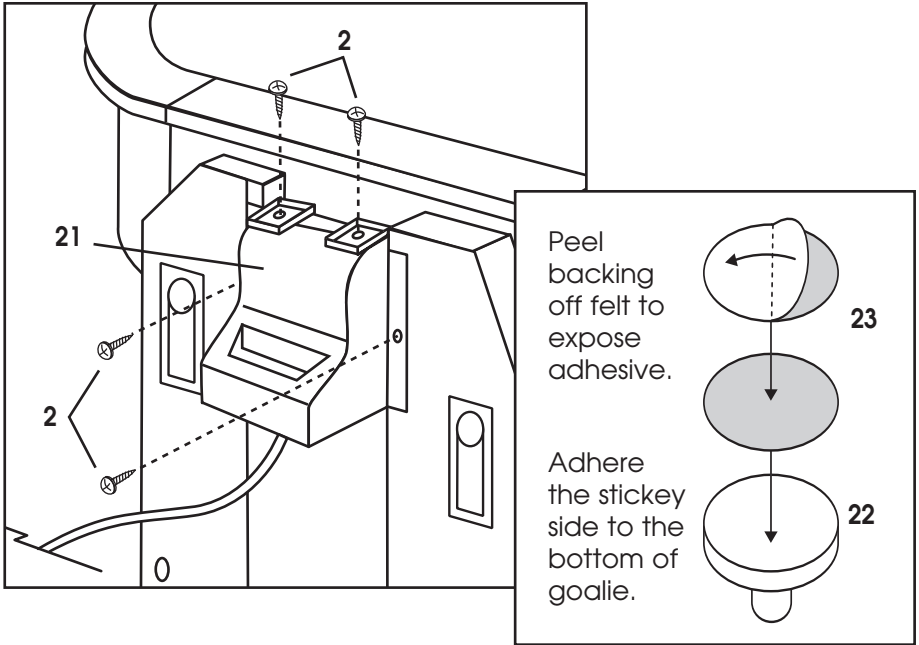

STEP 5. Attaching the Puck Catchers

Align (#21) puck catcher with predrilled holes on each end of playing table and secure to pedestal with (#2) $\frac{1}{2}$ " round head screws. Run the power cord through the puck catcher.

STEP 6. Adjust Levelers













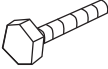

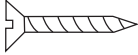

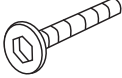
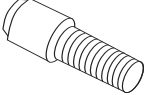

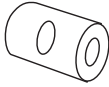
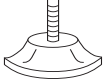

With the help of another person, turn each leveler until table rests level to the floor. Check with a level placed cross-wise and length-wise on table top. Readjust levelers as necessary.

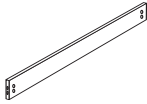
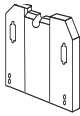
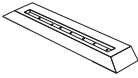
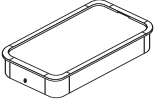
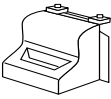
STEP 7. Assembling Goalies

Remove and discard sticky backer from (#23) goalie felt sticker and apply to (#22) goalie.

You are now ready to play!

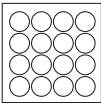
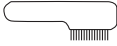
Pockey™ 2 in 1 Gametable Parts List

<p>#1.</p>  <p>5/8" Hex Bolt 8 pieces</p>	<p>#2.</p>  <p>1/2" Round Head Screw - 8 pieces</p>	<p>#3.</p>  <p>2 1/2" Hex Bolt 8 pieces</p>	<p>#4.</p>  <p>5/8" Washer 8 pieces</p>	<p>#5.</p>  <p>1 1/2" Flat Head Screw - 6 pieces</p>
<p>#6.</p>  <p>20mm Hex Nut 2 pieces</p>	<p>#7.</p>  <p>20mm Washer 6 pieces</p>	<p>#8.</p>  <p>1/2" Allen bolt 8 pieces</p>	<p>#9.</p>  <p>Lock Bolt 2 pieces</p>	<p>#10.</p>  <p>5/16" Washer 8 pieces</p>
<p>#11.</p>  <p>1 3/8" Large Washer 8 pieces</p>	<p>#12.</p>  <p>7/16" Washer 8 pieces</p>	<p>#13.</p>  <p>1" Round Head Screw 8 pieces</p>	<p>#14.</p>  <p>Bolt Stop 8 pieces</p>	<p>#15.</p>  <p>Leveler 4 pieces</p>
<p>#16.</p>  <p>Table Lock 4 pieces</p>	<p>#17.</p>  <p>Side Rail 2 pieces</p>	<p>#18.</p>  <p>Pedestal 2 pieces</p>	<p>#19.</p>  <p>Pedestal Support 2 pieces</p>	<p>#20.</p>  <p>Table Top 1 piece</p>
<p>#21.</p>  <p>Puck Catcher 2 pieces</p>	<p>#22.</p>  <p>Goalie 2 pieces</p>	<p>#23.</p>  <p>Goalie Felt Sticker 2 pieces</p>	<p>#24.</p>  <p>Round Puck 1 piece</p>	<p>#25.</p>  <p>Wrench 2 pieces</p>
<p>#26.</p>  <p>Chalk 2 pieces</p>	<p>#27.</p>  <p>2 Cue Sticks 4 pieces</p>	<p>#28.</p>  <p>Billiard Balls 1 set</p>	<p>#29.</p>  <p>Brush 1 piece</p>	<p>#30.</p>  <p>Triangle 1 piece</p>

WARRANTY INFORMATION

90-Day Warranty on Pockey™ Table

Manufacturer warrants to the original retail purchaser, this product to be free from defects in material and workmanship for a period of ninety (90) days from the date of purchase.

Should this product become defective due to material or workmanship within the warranty period, contact our Customer Service Department. This warranty is not transferable and does not cover normal wear and tear, or damage caused by improper handling, installation or use of this product. This warranty is also void if product is in any way abused, damaged, or modified from its original state, or if used for other than indoor residential use. This warranty gives you specific legal rights, and you may have other rights which vary from state to state.

DO NOT RETURN TO STORE

For all returns and warranty coverage, please visit our website at www.gldmfg.com or call 1-800-225-7593. Please provide model number, serial number and/or part number when you call. Numbers can be found on outside of packaging.



PRO GAME TABLES

GLD Products

S84 W19093 Enterprise Drive

Muskego, WI 53150 USA

800 225 7593 • FAX 800 841 6944

Web Site: www.gldmfg.com

Email: gld@gldmfg.com