

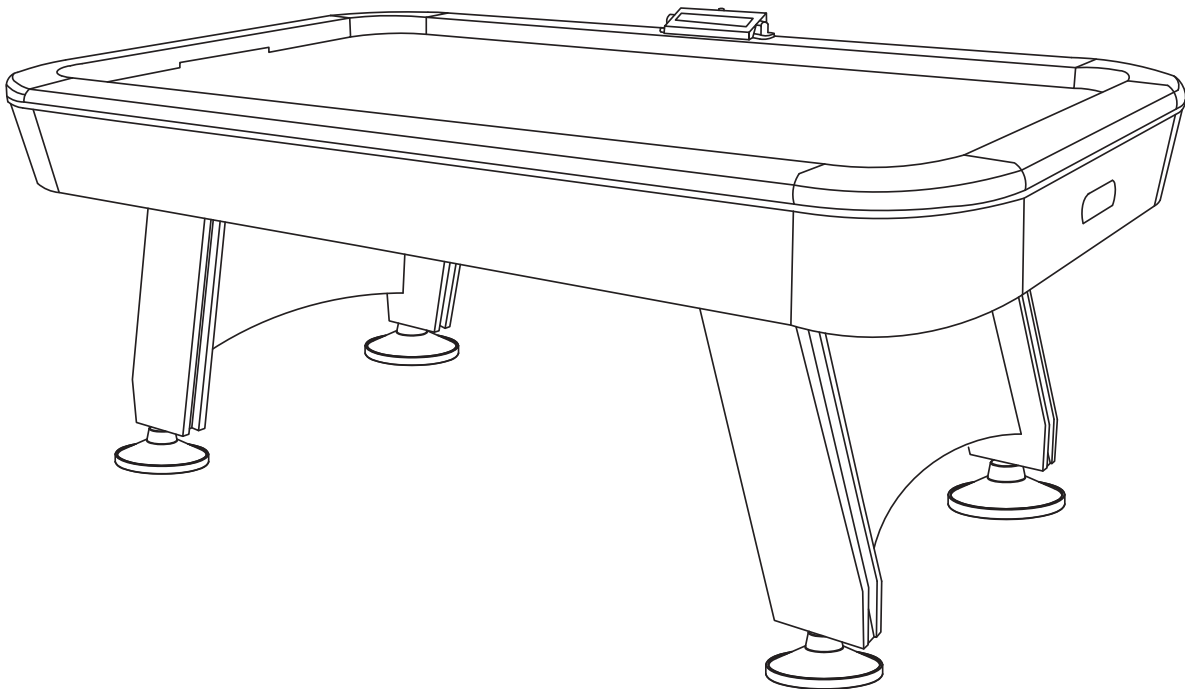

*Arctic Ice Air Powered
Hockey Table*

Item 64-3006

**ARCTIC ICE AIR POWERED
HOCKEY TABLE**



Replacement Parts

Order direct at www.gldproducts.com
or call our Customer Service department at
(800) 225-7593
8 am to 4:30 pm Central Standard Time

GLD Products

**Arctic Ice Air Powered
Hockey Table**

Item 64-3006

Staple your receipt here.

Important: A copy of your receipt will be needed to activate your warranty (see page 14).

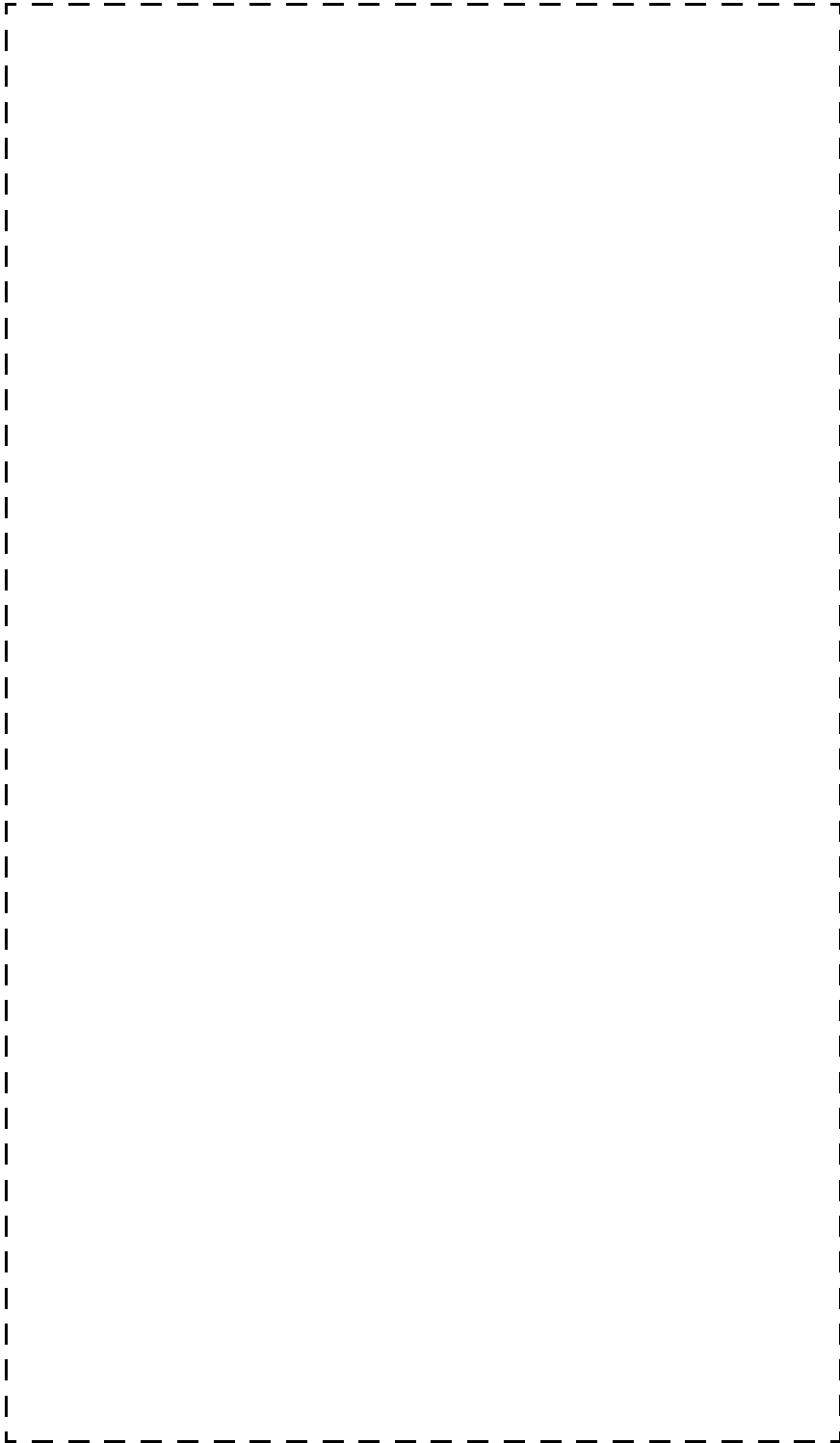



Congratulations and THANK YOU for purchasing the Arctic Ice Air Powered Hockey Table. You have chosen a product that should provide years of entertainment. To assist you with customer service and warranty claims, staple your receipt to the inside cover, then keep this manual in a safe place for future reference.













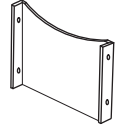

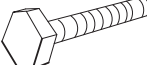

GLD Products

S84 W19093 Enterprise Drive
Muskego, WI 53150 USA
1-800-225-7593
Fax: 1-800-841-6944
Email: gld@gldmfg.com
Web: www.gldproducts.com

This manual may have been updated. For the latest manual visit the GLD Products website.

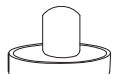
	<p>Place your package near the location where it will be used. Carefully unpack all components and verify you have all the correct pieces.</p> <p>If you notice missing or defective parts, please call us at: 1-800-225-7593.</p>
---	---

	<p>Please read and understand all instructions before beginning assembly.</p> <p>This assembly will require 2 adults.</p> <p>This product is not for use by children without adult supervision.</p>
---	--

Part No./ Qty	Illustration/ Order Number	Part No./ Qty	Illustration/ Order Number	Part No./ Qty	Illustration/ Order Number
1 Qty. 2	 Left Leg Order No. 4-128	2 Qty. 2	 Right Leg Order No. 4-129	3 Qty. 2	 Leg End Panel Order No. 4-130
4 Qty. 1	 Scoreboard Order No. 4-131	5 Qty. 4	 Leg Leveler Order No. 4-132	6 Qty. 8	 1/4" x 1" Bolt Order No. 4-133
7 Qty. 8	 5/16" x 2-3/4" Bolt Order No. 4-134	8 Qty. 16	 5/16" Washer x 23 mm Order No. 1-14	9 Qty. 8	 5/16" Nut Order No. 2-139
10 Qty. 2	 5/8" Screw Order No. 4-135	11 Qty. 4	 Hockey Felt Order No. 2-19	12 Qty. 4	 Hockey Puck Order No. 2-20
13 Qty. 4	 Goalie Order No. 2-18	14 Qty. 1	 Adapter Order No. 4-136	15 Qty. 1	 Wrench Order No. 1-17
16 Qty. 1	 Allen Wrench Order No. 2-116	17 Qty. 1	 Table Top Assembly Order No. 4-137		

IF YOU HAVE A WARRANTY CLAIM, CALL US FIRST

Please see page 14.

GLD Products

Available 8 am to 4:30 pm Central Standard Time

S84 W19093 Enterprise Drive
Muskego, WI 53150 USA
1-800-225-7593
Fax: 1-800-841-6944
Email: gld@gldmfg.com
Web: www.gldproducts.com

For all claims, please have your receipt and item number when you call. The product item number can be found on the front cover.

If you are instructed to return the product for service, you are responsible for shipping the unit at your expense.

PRODUCT REGISTRATION

Important: The product registration form on page 15 and a copy of your receipt must be completed and returned within 10 days of purchase to validate your warranty.

Preparing for Assembly

- Be sure to unpack all of the parts included in this package. Check inside any tubes or sleeves. Save all packing material until the product is fully assembled and functional.
- Compare the parts in your package with the Parts Identifier description on page 4.
- After unpacking large products, some disassembly may be required prior to beginning the assembly.

Tools Required

- Open end wrench (#15) - included with table
- Phillips screwdriver (not included)
- Level (not included)
- Electric screwdriver may be helpful. **CAUTION:** You must set at LOW TORQUE and use extreme caution because you could overtighten the hardware, strip the screws, or damage the table.

Assembly Tips

Make sure you understand the following before you begin to assemble your game table.

1. READ THIS MANUAL all the way through before beginning assembly.
2. When installing parts that have more than one bolt, start ALL bolts in that part by hand before tightening anything.
3. Some drawings or images in this manual may not look exactly like your product.
4. You may need a second adult to assist with this assembly.

Note: Save all packing materials until the parts have been inspected and the table is assembled.

Unpack the Pieces

- Lay the box on a flat surface (floor). You may want this near your area of assembly.
- Unpack the boxes and part bags. Inspect and count the parts. The Parts Identifier page can be used to record your results.
- If any parts are damaged or missing, contact GLD Customer Service.
- Missing fasteners may be purchased at a hardware store using the descriptions on the Parts Identifier page.

Games

This game table includes the equipment and game pieces for Air Powered Hockey. The rules for this game are not discussed in this manual.

STEP 1 - ASSEMBLE THE LEGS

Each leg has three main pieces. The two leg panels (#1 & #2) are not the same. Locate the screw holes that the leg end panels (#3) screw into.

1. Position leg end panel (#3) against one of the legs (#1 or #2). Note the positioning of the straight side on the leg and the ends of the leg panel. Use two bolts (#6) to hold the two panels together.
2. Position the second leg and use two bolts (#6) to secure the two panels together.
3. Tighten the four bolts.
4. Repeat to assemble the other two legs and leg end panel.
5. Screw a leg leveler (#5) into the center hole of each leg. The leveler (#5) is screwed half-way in.
6. Repeat for the remaining three legs.

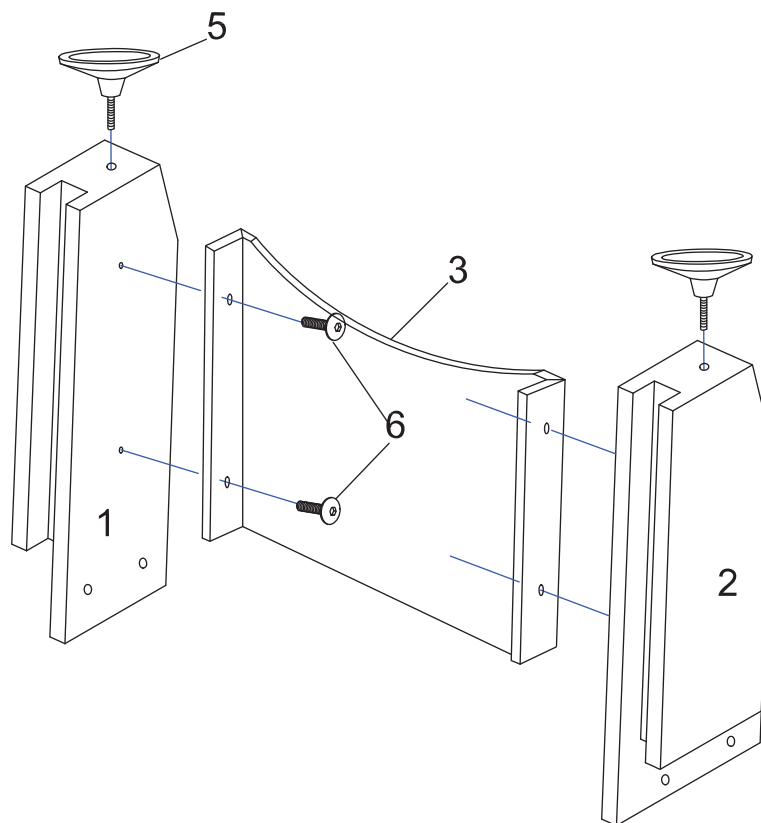

STEP 2 - ATTACH THE LEGS

Both of the leg assemblies are the same.

1. Place the table top (#17) on the flat floor. The bottom must be facing up.
2. Position a leg assembly so the straight edge of the legs and the inside of the leg end panel faces inward toward the center of the table.
3. Insert a bolt (#7) and washer (#8) into both holes through the table top assembly. The bolts go through the holes in the leg. Place a washer (#8) and hand start a nut (#9) on each bolt. Repeat for the second leg assembly.

NOTE: Some tables may use a metal flange in place of a nut (#9). These tables will have the flange already attached. The bolt (#7) and washer (#8) are then inserted and tightened. A nut is not used.

4. After each leg assembly has all four bolts/nuts hand tightened, use the wrench (#15) to tighten fully.

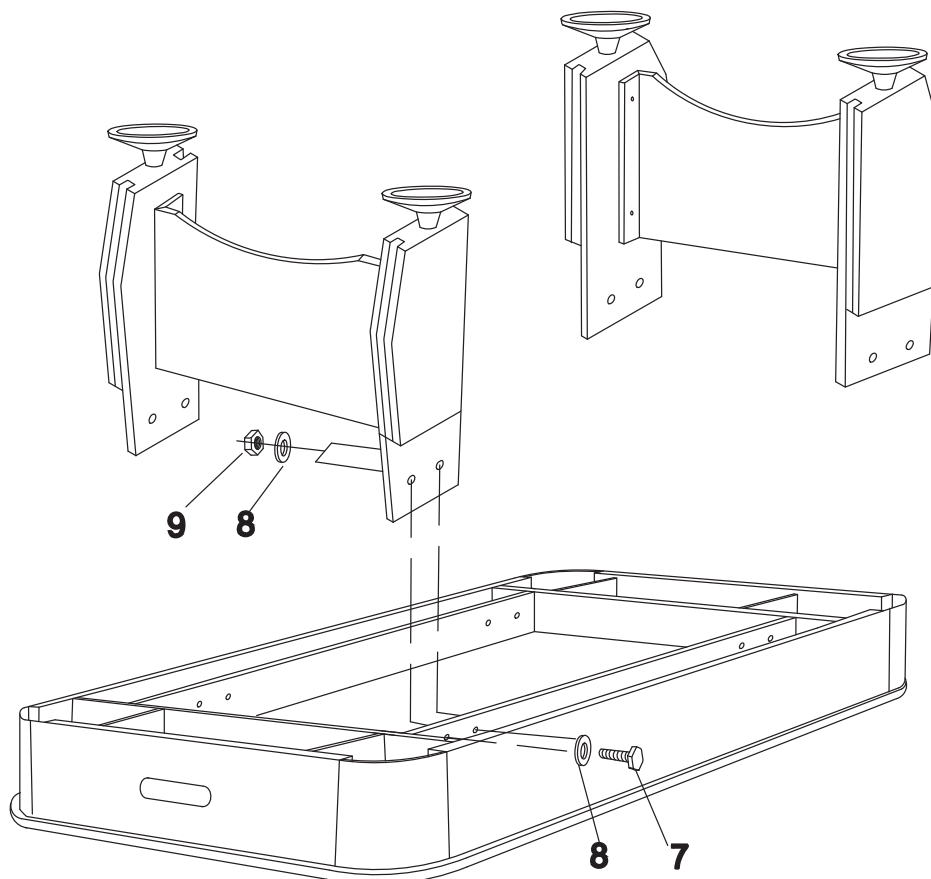

STEP 3 - TURN THE TABLE OVER

The table is ready to be turned over.

USE AT LEAST TWO PEOPLE TO LIFT THE TABLE ASSEMBLY AND TURN IT OVER TO REST ON THE LEGS.

DO NOT ROLL THE TABLE OVER. This will place a sideways force on the legs. The legs should be off the floor until the table assembly is rotated completely. Set the table down.

DO THIS

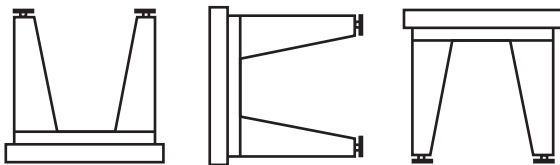

NOT THIS

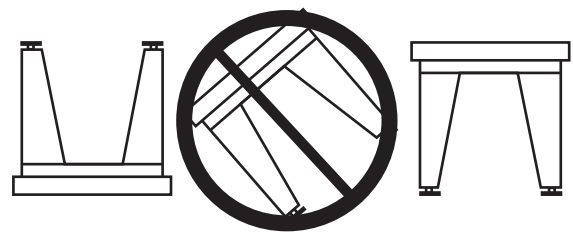

STEP 4 - MOUNT THE SCOREBOARD

The wiring on the underside of the table should be secure. The two connections to the scoreboard should be pulled through the holes in the table top.

1. Position the scoreboard (#4) over the holes in the table side rail.
2. Connect both puck goal wires to the scoreboard. Set the scoreboard on the table surface by pushing the wires back into the holes.
3. Hold the scoreboard (#4) in position and insert two screws (#10) into the table top to hold the scoreboard. Tighten the screws.

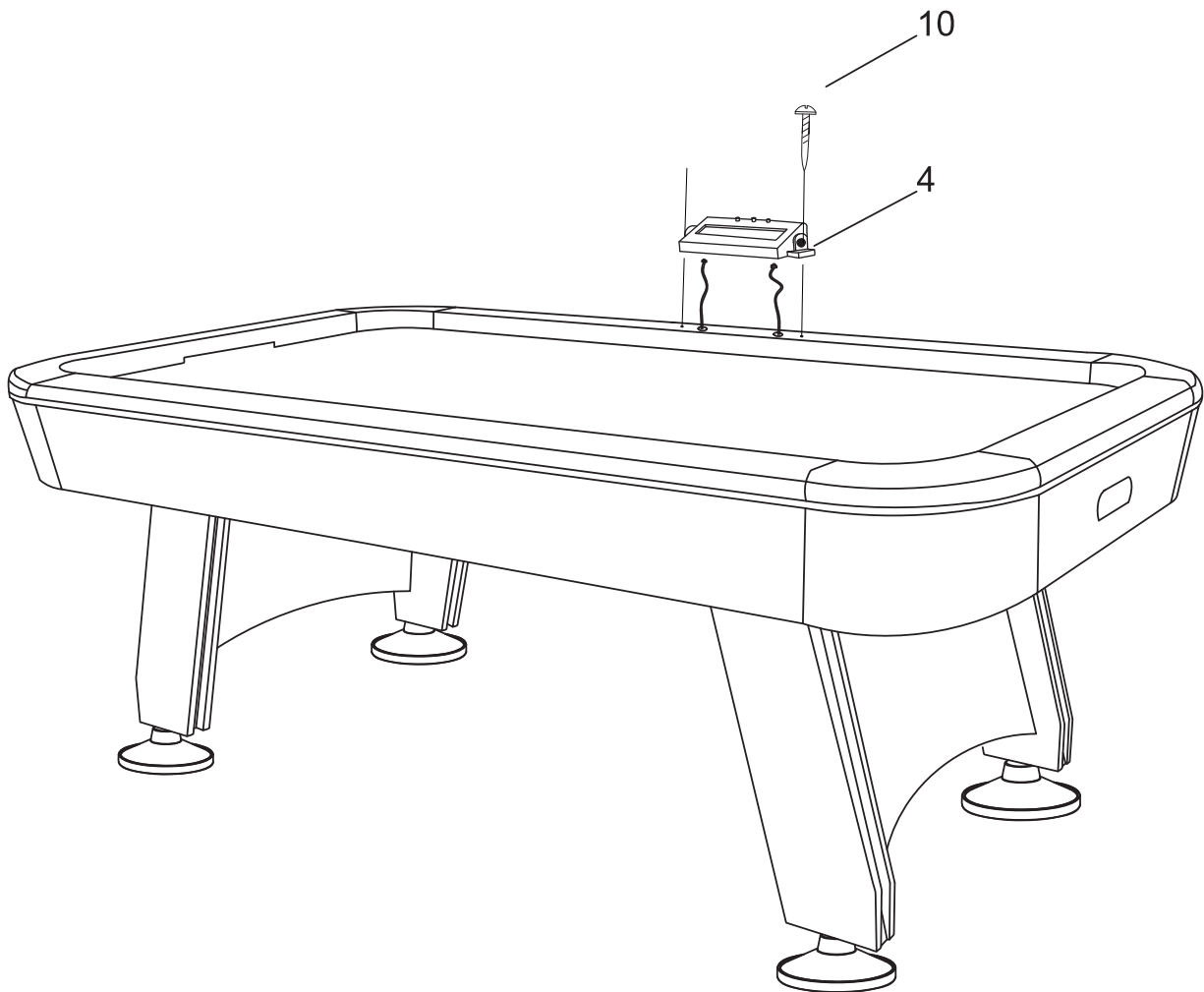

STEP 5 - APPLY POWER

The scoreboard can be powered by the power adapter (#14) or four AA batteries (not included).

To use the power adapter (#14), plug the small round end into the scoreboard. Plug the large end into the plug under the table top.

To use batteries, open the battery tray using a screwdriver. Slide the tray open. Observe the battery placement shown inside the tray. Insert four AA batteries and close the tray. Reinsert the screw and tighten.

Plug the electrical cord from under the table into a standard wall plug.

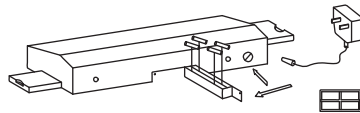
**STEP 6 - OPERATION**

1. Test the score keeping system by pressing the main power switch and the scoreboard switch on. The scoreboard and fan will turn on. One window displays the time remaining the other two windows display the home and visitor scores.
2. Press the reset button. Push a puck (#12) into a goal. The score will display as either home or visitor. The two wires from the goals can be switched at the control box under the table top. Switching these wires will reverse which goal scores for the home and visitor teams. Turn the game off by pressing power button to OFF.
3. The length of a game is normally 15 minutes. To change this to 10 or 5 minutes, press the select button.
4. Press the reset button to start a game.

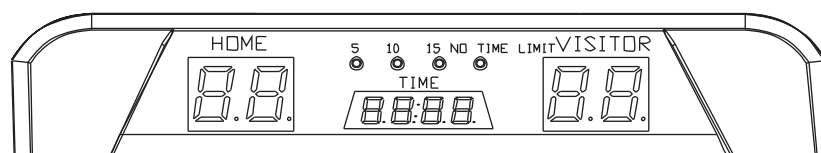

STEP 7 - LEVEL THE TABLE

1. Place the table in position.
2. Use a carpenters level to find the low side of the table.
3. Raise or lower the leg levelers as needed to level the table.
4. Level the table side-to-side and end-to-end. When the game is turned on, the puck will float to a low side. Final leveling can be performed if needed.

STEP 8 - ASSEMBLE GOALIE

1. Peel paper from one of the hockey felt pieces (#11).
2. Attach the felt to the bottom of the goalie (#13).

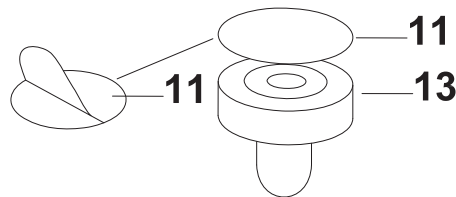
**Care and Use of your Table**

- This product is intended for INDOOR use only.
- DO NOT sit, climb, or lean on the table.
- DO NOT drag the table when moving it. This will damage the legs.
- Keep your table covered.
- To clean the hard surfaces spray a cloth with a mild cleaner and wipe.
- Pucks that fly off the table may have chipped edges. Inspect the puck and replace if needed.
- The air holes may become plugged, causing the puck to drag. A small drill bit can be used to re-open the holes. DO NOT use a power drill. Instead, hold the drill bit in your fingers and clear the holes.

90-DAY LIMITED WARRANTY

The Manufacturer warrants to the original retail purchaser that this product is free from defects in material and workmanship under normal use and conditions for a period of ninety (90) days from the date of original purchase. The Manufacturer's liability is limited to the repair or replacement, at its option, of any defective product and shall not include any liability for indirect, incidental or consequential damages of any kind. Should this product become defective due to material or workmanship within the warranty period, contact our Customer Service Department. This warranty is not transferable and does not cover normal wear and tear or damage caused by improper usage, negligence, misuse, abuse, transportation damage, acts of nature, or accident (including failure to follow the instructions in this manual). It does not cover expendable items such as batteries, light bulbs, fuses, accessories, cosmetic parts and other items that wear out due to normal usage, including felt covered areas of the playing surface. This warranty is also void if the product is disassembled and reassembled, damaged, modified from its original state, or used for other than indoor personal residential use (no commercial or rental applications).

This warranty gives you specific legal rights, and you may have other rights which vary from state to state.

IF YOU HAVE A WARRANTY CLAIM, CALL US FIRST (8 - 4:30 CST)

Please have your receipt and item number (found on the front cover) when you call.

GLD Products

S84 W19093 Enterprise Drive
Muskego, WI 53150 USA
1-800-225-7593
Fax: 1-800-841-6944
Email: gld@gldmfg.com
Web: www.gldproducts.com

If you are instructed to return the product for service, you are responsible for shipping the unit at your expense to the above address in packaging that will protect against further damage. All warranty or repair requests require a Return Authorization Number prior to returning the item.

PRODUCT REGISTRATION

Important: The product registration form on page 15 must be completed and returned along with a copy of your receipt within 10 days of purchase to validate your warranty.

REGISTER YOUR PRODUCT

Place postage here

Complete this form, include a copy of your receipt, fold, tape (do not staple) and return within 10 days of purchase. This protects your warranty and will help us develop new products!

Cut here.

GLD Products
 Warranty Department
 S84 W19093 Enterprise Drive
 Muskego, WI 53150 USA

Fold here second.



P R O D U C T S

www.gldproducts.com

- | | |
|-----------------------|----------------------------|
| GAME TABLES | HOME CASINO |
| GAMES AND ACCESSORIES | BILLIARD CUES |
| BILLIARD ACCESSORIES | DARTBOARDS |
| SOFT-TIP DARTS | STEEL-TIP DARTS |
| FLIGHTS AND SHAFTS | DART CASES AND ACCESSORIES |

Fold here first.

Name		Date of Purchase	
Address		Phone-Day	
City		Phone-Evening	
State	Zip	Email	
Purchase Price:		Item: 64-3006 Arctic Ice Air Powered Hockey Table	
Store Name:			

1. What are the top two reasons that influenced the purchase of this product? Select two.

- | | | | |
|--------------------------|-------------------------|--------------------------|---|
| <input type="checkbox"/> | Brand reputation | <input type="checkbox"/> | Prior experience with another GLD product |
| <input type="checkbox"/> | Saw in an advertisement | <input type="checkbox"/> | Color/appearance |
| <input type="checkbox"/> | Quality/durability | <input type="checkbox"/> | Other |
| <input type="checkbox"/> | Value for price | | |

2. How did you become aware of this product? Select two.

<input type="checkbox"/>	Saw in an advertisement	<input type="checkbox"/>	Saw it in the store
<input type="checkbox"/>	Saw or used a friend's or relative's	<input type="checkbox"/>	Recommended by another person
<input type="checkbox"/>	Received as a gift	<input type="checkbox"/>	Other

3. Rate your satisfaction with each of the following?

	Excellent	Good	Fair	Poor
Assembly instructions				
Ease of assembly				
Packaging				
Overall product satisfaction				

4. Were there any parts missing?

Yes No If so, which ones? Order No. _____

5. Based on your experience, would you buy another GLD product?

Yes No

6. Is this the first GLD product that you've owned? If No, what other product have you owned?:

Yes No _____

7. Have you owned products from:

Sportcraft Harvard Classic Sport Other

8. When did you decide to purchase this product?

Before entering the store. While in the store/impulse purchase

9. How many times per month will you use it?

1 to 3 4 to 8 9 to 15 16 +

10. Are you the intended user of this product?

Yes No, indicate who: _____

11. Where will you use this product?

Home Other: _____

12. Please tell us your gender?

Male Female

13. And your marital status?

Married Single

14. Age?

Under 25 25 - 40 40 - 60 Over 60

15. Which best describes your family income?

<input type="checkbox"/>	Under \$25,000	<input type="checkbox"/>	\$25,000 - \$49,999	<input type="checkbox"/>	\$50,000 - \$99,999
<input type="checkbox"/>	\$100,000 - 149,999	<input type="checkbox"/>	\$150,000 - \$199,999	<input type="checkbox"/>	Over \$200,000

16. Education:

<input type="checkbox"/>	Some high school	<input type="checkbox"/>	College degree
<input type="checkbox"/>	Completed high school	<input type="checkbox"/>	Graduate degree

Remember to attach a copy of your receipt.

Method of Payment

_____ Check or Money Order
_____ Credit Card

_____ Visa _____ MasterCard _____ Discover _____ American Express

Card # _____

Security Code # _____ Billing Address Zip code _____

Signature _____ Exp. Date _____

Shipping Address

Name _____

Address _____ Phone _____

City _____ State _____ Zip _____

GLD[®]

P R O D U C T S

www.gldproducts.com

GAME TABLES

HOME CASINO

GAMES AND ACCESSORIES

BILLIARD CUES

BILLIARD ACCESSORIES

DARTBOARDS

SOFT-TIP DARTS

STEEL-TIP DARTS

FLIGHTS AND SHAFTS

DART CASES AND ACCESSORIES



PROUD MANUFACTURER OF



S84 W19093 Enterprise Drive • Muskego, WI 53150 USA
262.679.8730 or 1.800.225.7593 tele
262.679.8738 or 1.800.841.6944 fax
262.679.8739 international fax
Email: gld@gldmfg.com
www.gldproducts.com